

DESIGN FEATURES

DURABLE

- No-pin connection, 1 pc blow-out proof stem
- DI/CI Nodularity over 95%

ANTI-CORROSION

- Material: Epoxy powder:  , Earth Best!
- Coating Thickness: 200-250µm
- Spraying temp: over 200°C. Doesn't fade, even wipe with diethyl ether

QUALITY STANDARD

- 100% quality test, follow DIN, ASTM, JIS, GB/T, ISO, BS EN, API
- ONLY ONE Manufacturer get CE certification up to DN1800
- 2 years warranty. 15000 times On-off test, 30000 times Destructive experiment

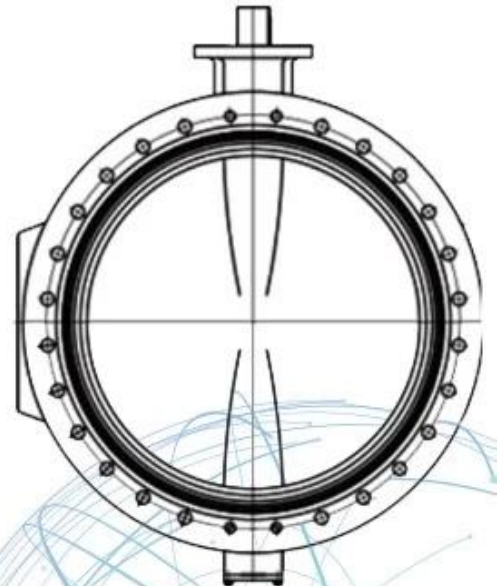
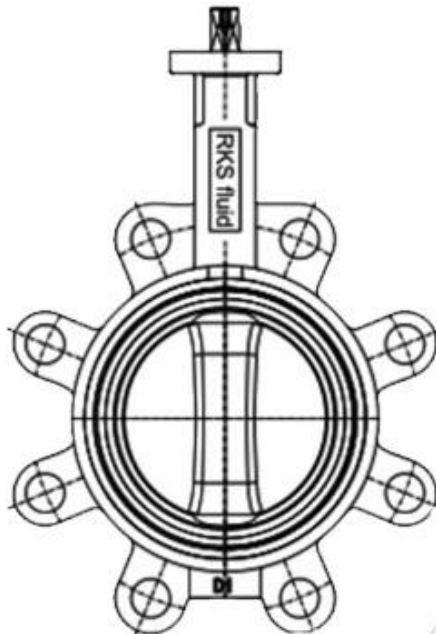
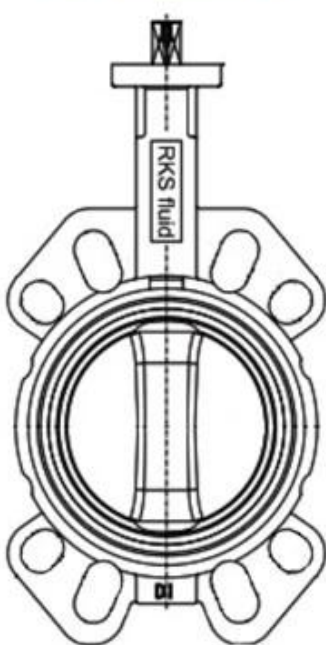

Taille	DN32 - DN2400 (NPS1 1/4-NPS96)
Pressions nominales	PN6 - PN10 - PN16 (Classe 150)
Écart de température	-40 °C-120 °C
Matériel	Fonte ductile, acier inoxydable, etc.
Matériau du siège	NBR, EPDM, caoutchouc naturel, silicium, Viton

Connexion

Plaque, cosse, section en U, double bride

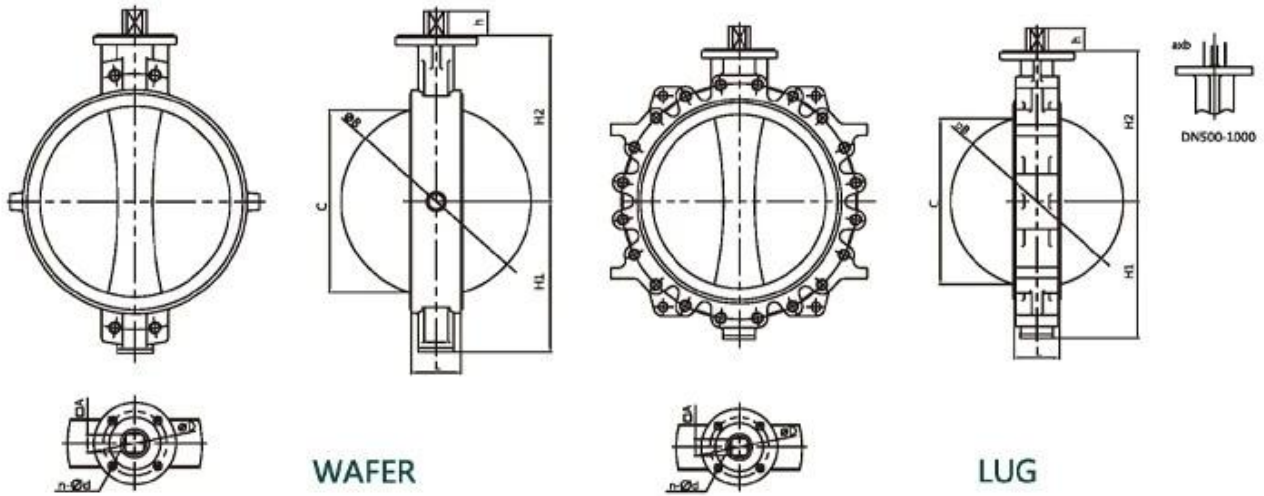

WAFER

LUG

NPS14-NPS40 Wafer/Lug with alignment holes													
Size	L	H1	H2	h	A	ΦB	C	ΦG	a	b	ΦD	n-Φd	ISO5211
NPS14	3.07	10.63	11.81	1.42	1.06	Φ13.31	12.95	-	-	-	Φ4.92	4-Φ0.55	F12
NPS16	4.02	11.81	13.58	1.69	1.26	Φ15.35	14.80	-	-	-	Φ5.50	4-Φ0.71	F14
NPS18	4.49	12.99	14.76	1.93	4.42	Φ17.20	16.61	-	-	-	Φ5.50	4-Φ0.71	F14
NPS20	5.00	15.16	16.73	2.56	-	Φ19.09	18.43	Φ2.36	0.71	2.52	Φ6.50	4-Φ0.87	F16
NPS24	6.06	17.24	19.49	2.76	-	Φ23.03	22.24	Φ2.36	0.71	2.52	Φ6.50	4-Φ0.87	F16
NPS28	6.50	20.39	22.44	3.15	-	Φ26.77	25.98	Φ2.76	0.79	2.93	Φ10.00	8-Φ0.71	F25
NPS30	6.50	21.46	24.02	3.15	-	Φ28.74	27.95	Φ2.76	0.79	2.93	Φ10.00	8-Φ0.71	F25
NPS32	7.48	22.32	25.20	3.15	-	Φ30.43	29.49	Φ2.76	0.79	2.93	Φ10.00	8-Φ0.71	F25
NPS36	7.99	25.59	27.56	3.94	-	Φ34.49	33.54	Φ3.15	0.87	3.35	Φ10.00	8-Φ0.71	F25
NPS40	8.50	28.15	29.53	3.94	-	Φ38.43	37.48	Φ3.15	0.87	3.35	Φ11.73	8-Φ0.87	F30

APPLICATION SCENARIO



Industrial water application



Power plant



Sea water desalination



Water treatment



Water supply and drainage



HAVC



Food and drug



Water transport



COMPANY INFORMATION



I Domaine d'activité : produits de contrôle des fluides, produits technologiques et de protection de l'environnement.

II Centres d'usinage CNC avancés, cellules de traitement professionnelles, équipements de soudage à large gamme, lignes d'assemblage et revêtement automatiques.

III L'unité de référence standard de la Chine, pour participer à l'élaboration des normes pertinentes de l'industrie des vannes.

IV Nous avons créé un centre de recherche et développement à Houston, au Texas, aux États-Unis.

V Norme de produit : GB, norme allemande, norme américaine, TUV CE, ISO 9001, ADWO-2000, TS, PED, WRC WRAS, KTW, API 6D, API609.

VI Production principale : [vanne papillon](#), robinet à tournant sphérique, robinet-vanne, clapet anti-retour, robinets à soupape, raccords de tuyauterie, actionneur manuel/pneumatique/électrique, pièces de vanne.



01

21 years of professional experience

03

Independent research and development team
28 top senior professional researchers

05

100% high level ex-factory inspection

07

2 years quality assurance, repair and replacement

4 factories

02

2 professional testing centers

04

High quality imported materials

06

COMPANY QUALIFICATION



COMPANY EXHIBITION



Partners



Delivery



Payment



FAQ:

Q : Si j'ai besoin d'un devis, de quelles informations avons-nous besoin ?

A : Matériaux des vannes, température, pression, fluide, système d'application.

Q : Pouvez-vous fournir des actionneurs, ce que vous avez ?

A : Électrovannes pneumatiques, électriques, hydrauliques. RKSfluid les actionneurs adoptent la technologie américaine. Ce dont vous avez besoin, dites-le-nous.

Q : Quelle est votre capacité de production ?

UN: RKSfluid dispose de quatre usines qui peuvent fournir les produits dont vous avez besoin.

Q : Délai de production

R : Les produits normaux sont en stock sous 2 à 5 jours ouvrables. Base personnalisée selon vos besoins.

Q : MOQ

R : 1 pièce pour tous les produits.

Q : Qu'en est-il de l'assurance qualité ?

R : Test de qualité à 100 % avant la livraison, 2 ans de garantie. Assurez la sécurité de fonctionnement de votre système.

Nous avons obtenu les certifications TUV, API, WRAS, CE, ISO.

Norme conforme aux normes DIN, ASME, BS EN, JIS, API, AWWA.

Q : Comment pourriez-vous fournir un service de qualité à nos clients ?

UN: RKSfluid possède 27 ans d'expérience et plus de 70 ingénieurs R&D vous fournissent une assistance technique, une sélection de modèles et des conseils d'installation.