

## Features□

1. Long service life with reliable seal and without frequent maintenance.

2. Pressure Loss

Too much pressure loss will bring increased cost of correlative energy. Butterfly valve have flow characteristics three times better than globe valve, and about 75% of a same size gate valve.

3. Multi-Function

Butterfly valve can be used for on/off service and throttling. They are superior in Multi-function as compared to gate valves. Butterfly valve can be widely used in chemical field due to trim options and choice of elastomeric liner.

4. Weight

Butterfly valve have feature of light in weight and small in size, for example, weight and size of a 10" butterfly valve are 1/9 and 1/6 of a 10" gate valve. So, butterfly valve is easy to be installed and saves cost of piping system.

5. Bubble Tight

Butterfly valve with resilient seat design can be bubble tight as compared to metal seated gate or globe valves.

6. Easy of operation

Butterfly valve offer 90-degree open to close.

7. Maintenance

Properly installed butterfly valves are self-cleaning and are less susceptible to failure due to trash material in pipe.

## DESIGN FEATURES

### DURABLE

- No-pin connection, 1 pc blow-out proof stem
- DI/CI Nodularity over 95%

### ANTI-CORROSION

- Material: Epoxy powder:  , Earth Best!
- Coating Thickness: 200-250µm
- Spraying temp: over 200°C. Doesn't fade, even wipe with diethyl ether

### QUALITY STANDARD

- 100% quality test, follow DIN, ASTM, JIS, GB/T, ISO, BS EN, API
- ONLY ONE Manufacturer get CE certification up to DN1800
- 2 years warranty. 15000 times On-off test, 30000 times Destructive experiment

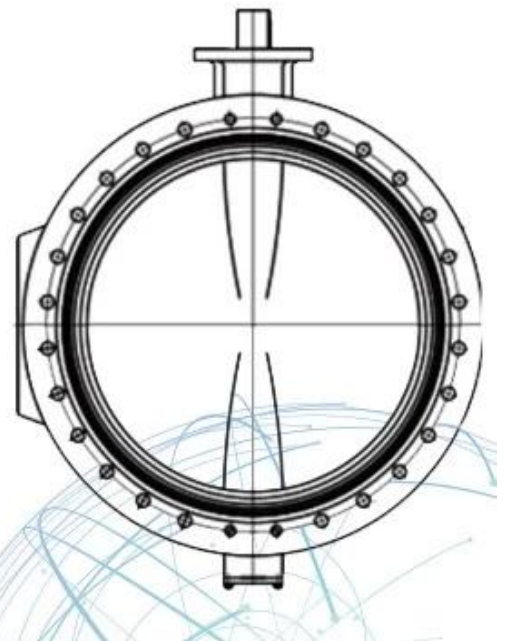
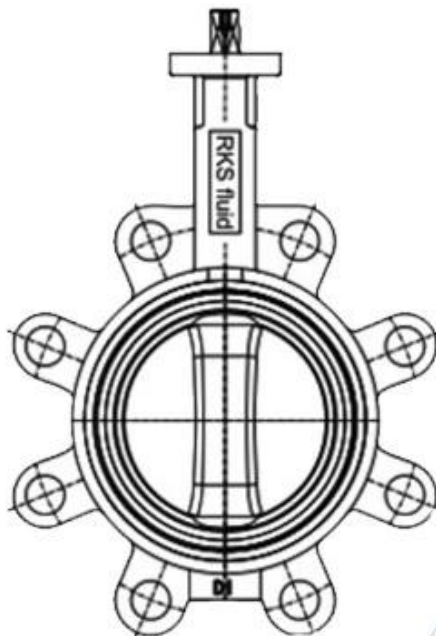
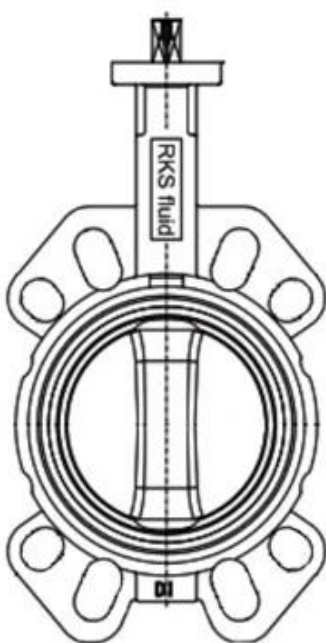

Size	DN32 - DN2400 □NPS1 1/4-NPS96)
Pressure ratings	PN6 - PN10 - PN16 (Class 150)

Temperature range	-40°C+120°C
Material	Ductile iron, Stainless steel etc.
Seat material	NBR, EPDM, Nature rubber, Silicon, Viton
Connection	Wafer, Lug, U-Section, Double flange

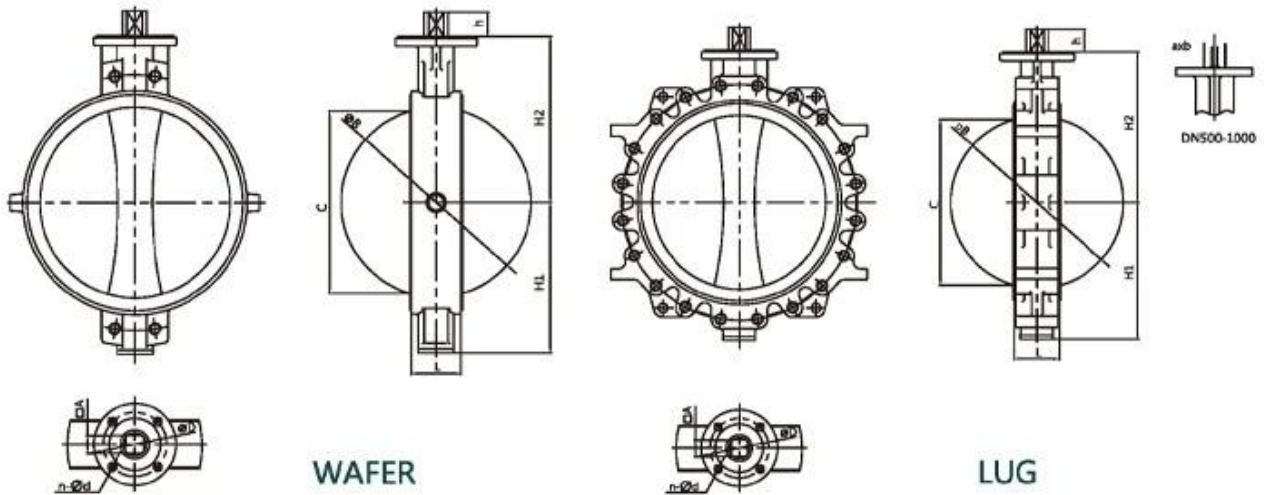

**NPS14-NPS40 Wafer/Lug with alignment holes**

Size	L	H1	H2	h	A	ΦB	C	ΦG	a	b	ΦD	n-Φd	ISO5211
NPS14	3.07	10.63	11.81	1.42	1.06	Φ13.31	12.95	-	-	-	Φ4.92	4-Φ0.55	F12
NPS16	4.02	11.81	13.58	1.69	1.26	Φ15.35	14.80	-	-	-	Φ5.50	4-Φ0.71	F14
NPS18	4.49	12.99	14.76	1.93	4.42	Φ17.20	16.61	-	-	-	Φ5.50	4-Φ0.71	F14
NPS20	5.00	15.16	16.73	2.56	-	Φ19.09	18.43	Φ2.36	0.71	2.52	Φ6.50	4-Φ0.87	F16
NPS24	6.06	17.24	19.49	2.76	-	Φ23.03	22.24	Φ2.36	0.71	2.52	Φ6.50	4-Φ0.87	F16
NPS28	6.50	20.39	22.44	3.15	-	Φ26.77	25.98	Φ2.76	0.79	2.93	Φ10.00	8-Φ0.71	F25
NPS30	6.50	21.46	24.02	3.15	-	Φ28.74	27.95	Φ2.76	0.79	2.93	Φ10.00	8-Φ0.71	F25
NPS32	7.48	22.32	25.20	3.15	-	Φ30.43	29.49	Φ2.76	0.79	2.93	Φ10.00	8-Φ0.71	F25
NPS36	7.99	25.59	27.56	3.94	-	Φ34.49	33.54	Φ3.15	0.87	3.35	Φ10.00	8-Φ0.71	F25
NPS40	8.50	28.15	29.53	3.94	-	Φ38.43	37.48	Φ3.15	0.87	3.35	Φ11.73	8-Φ0.87	F30

# APPLICATION SCENARIO



Industrial water application



Power plant



Sea water desalination



Water treatment



Water supply and drainage



HAVC



Food and drug



Water transport





## COMPANY INFORMATION



I Business area: fluid control products, technology and environmental protection products.

II Advanced CNC machining centers, professional process cells, wide-range welding equipment, automatic assembly lines and coating.

III China's standard reference unit, to participate in the development of relevant valve industry standards.

IV We have set up a research and development center in Houston, Texas, in the United States.

V Product Standard: GB, German Standard, American Standard, TUV CE, ISO 9001, ADWO-2000, TS, PED, WRC WRAS, KTW, API 6D, API609.

VI Main production: [butterfly valve](#), ball valve, gate valve, check valve, globe valves, pipe fittings, manual / pneumatic / electric actuator, valve parts.





01

21 years of professional experience

03

Independent research and development team  
28 top senior professional researchers

05

100% high level ex-factory inspection

07

2 years quality assurance, repair and replacement

4 factories

02

2 professional testing centers

04

High quality imported materials

06

## COMPANY QUALIFICATION



## COMPANY EXHIBITION





## Partners



### Delivery



### Payment



### FAQ:

**Q: If I need quotation, what informations do we need?**

A: Valves' materials, Temperature, Pressure, Medium, Applplication System.

**Q: Can you provide actuators, what you have?**

A: Pneumatic, Electric, Hrdraulic, Solenoid Valves. RKSfluid actuators adopt USA technology. Which you need, just tell us.

**Q: What's your productive capacity?**

A: RKSfluid has four plants that can provide the products you need.

**Q: Production lead time**

A: Normal products have stock in 2~5 working days. Customized base on your need.

**Q: MOQ**

A: 1pc for all products.

**Q: How about the quality assurance?**

A: 100% quality test before delivery, 2 years warranty. Ensure your system working safety.

We got TUV, API, WRAS, CE, ISO certification.

Standard conform to DIN, ASME, BS EN, JIS, API, AWWA.

**Q: How could you provide quality service to our customers?**

A: RKSfluid own 27 years experiences and more than 70 R&D engineers provide technical support, model selection and installation guidance for you.