

DESIGN FEATURES



Features



- Use AkzoNobel material.
- Super Anti-corrosion
- Epoxy powder coating 200-250um,
- Baking varnish over 200°C,

NO.		
1	Body	GGG50
2	Dise	GGG40+EPDM
3	Wedge nut	C48600
4	Stem	SS431
5	Bonnet	GT450-10
6	Gasket	EPDM
7	Y-ring	EPDM85-90
8	Fix ring	CuZn21Si3/C69300
9	Thrust bearing	C69300
10	Seal ring	EPDM70
11	O ring	NBR
12	Retainer ring	POM
13	Bushing ring	POM
14	Gland	SS431
15	Dustproof ring	EPDM85
16	Dise core	GGG40
17	Bolt	SS316

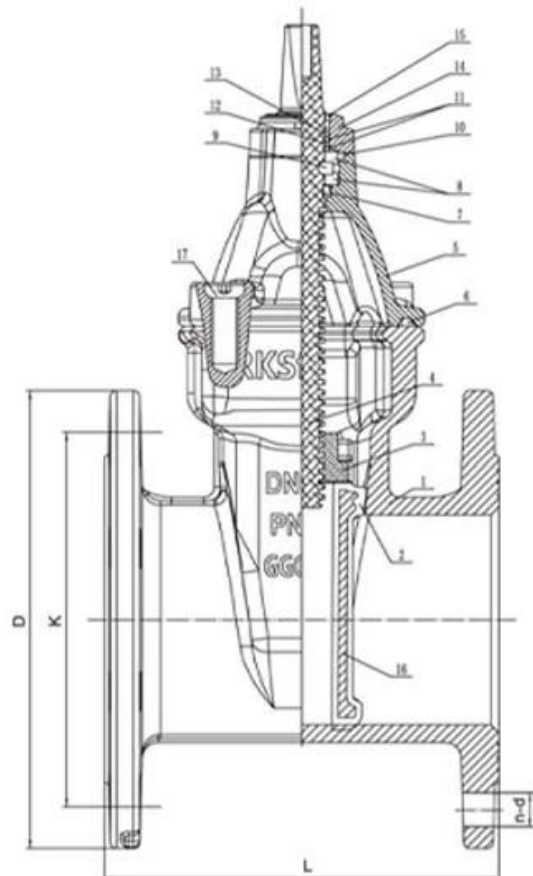



Free wedge nut, **reduces the stem bending forces** and at the same time enables it to be easily replaced.



The more compact new cap, reduces the water retention areas in order to reduce the risk of bacterial growth.



One piece stainless steel stem in for **better resistance to axial load and to with stand higher operating torques.**



Three locking tab for bayonet system prevents self-dismantling.



Dust guard integrating three O-ring shape, **prohibiting the introduction of foreign bodies** at the stem.



Male guiding system with composite sliding skate reduces the wear of the wedge against the body, allowing a smooth functionality and a longer life time of the valve.



Triple seal at the operating stem to ensure tightness with the test of time (2500 cycles).



New male composite sliding skate technology ensuring a low operating torque even under high differential pressure and preventing damage or corrosion generated by the friction.

RELATED PRODUCTS



APPLICATION SCENARIO



Industrial water application



Power plant



Sea water desalination



Water treatment



Water supply and drainage



HAVC



Food and drug



Water transport



COMPANY FACTORY



COMPANY INFORMATION



i 0000 00 : 00 00 00, 00 0 00 00 00.

CNC 00 00, 00 00 0, 0000 00 00, 00 00 00 0 00.

■ 00 00 00 000 000 000000 000 00 00 00.

000 0000 000 0000 00 00 000 000000.

v 00 00 : GB, 00 00, 00 00, TUV CE, ISO 9001, ADWO-2000, TS, PED, WRC WRA, KTW, API 6D, API609.

VI 00 0000 : 00 00, 0 00, 000 00, 00 00, 000 00, 000 00, 00 / 00 / 00 00000, 00 00.

01

21 years of professional experience

03

Independent research and development team
28 top senior professional researchers

05

100% high level ex-factory inspection

07

2 years quality assurance, repair and replacement

4 factories

02

2 professional testing centers

04

High quality imported materials

06

COMPANY QUALIFICATION



COMPANY EXHIBITION



□□□□ □□

Q : □□□ □□□ □□ □□ □□□ □□□□□?

A : □□□ □□, □□, □□, □□, □□ □□□.

Q : □□□□□□ □□ □ □ □□□□?

A : □□, □□, hydraulic, □□□□□ □□. RKSfluid □□□□□□ □□ □□□ □□□□□. □□□ □□□ □□ □□ □□□□ □ □□□□.

Q : □□ □□□ □□□□□?

A : RKSfluid□□ □□□ □□□ □□ □ □□□ 4 □□ □□□ □□□□.

Q : □□ □□ □□

A : □□ □□□ 2 ~ 5 □□□□ □□□ □□□□. □□□ □□□ □□ □□□ □□.

Q : **MOQ**

A : □□ □□□ □□ 1pc.

Q : □□ □□□ □□□□□?

A : □□ □ 100% □□ □□□, 2 □ □□. □□□□ □□□□ □□□□□□.

TUV, API, WRA, CE, ISO □□□ □□□□□□.

□□□ DIN, ASME, BS EN, JIS, API, AWWA□ □□□□□□.

Q : □□□□ □□□ □□□□ □□□ □□ □ □ □□□□?

A : RKSfluid □□□ 20 □ □□□ 70 □ □□□ R & D □□□□□ □□ □□, □□ □□ □ □□ □□□ □□□□□.