



RKSfluid®

A key Valve in Flow Control



Butterfly Valve

Ball Valve

Gate Valve

Globe Valve

Check Valve

Pipe Fittings



- Streamlined, minimum noise
- Backflow velocity only 0.2s, Head loss 0.1bar with 2m/s
- EPDM/NBR Rubber fully coated disc
- Anti-erosion design, Self-adjusting ball
- Self-cleaning stem, Long time smooth operation

Engineering Projects



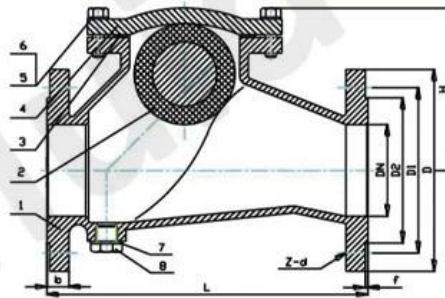

Ball Check Valve, Flange

ITEM	PART NAME	MATERIAL
1	Body	Ductile iron
2	Ball	NBR
3	Gasket	NBR
4	Body	Ductile iron
5	Bolt	SS304
6	Washer	SS304
7	Washer	Nylon
8	Plug	SS304

SIZE	DIN 3202 F6	Flange dimension(EN 1092-2) PN10/PN16		
DN	L	D	K	n-d
DN40/1.5"	180	150	110	4- ϕ 19
DN50/2"	200	165	125	4- ϕ 19
DN65/2.5"	240	185	145	4- ϕ 19
DN80/3"	260	200	160	8- ϕ 19
DN100/4"	300	220	180	8- ϕ 19
DN125/5"	350	250	210	8- ϕ 19
DN150/6"	400	285	240	8- ϕ 23
DN200/8"	500	340	295/295	8- ϕ 23/12- ϕ 23
DN250/10"	600	405	350/355	12- ϕ 23/12- ϕ 28
DN300/12"	700	460	400/410	12- ϕ 23/12- ϕ 28
DN400/16"	900	580	515/525	16- ϕ 28/16- ϕ 31
DNS00/20"	1100	715	620/650	20- ϕ 28/20- ϕ 34

Product Display

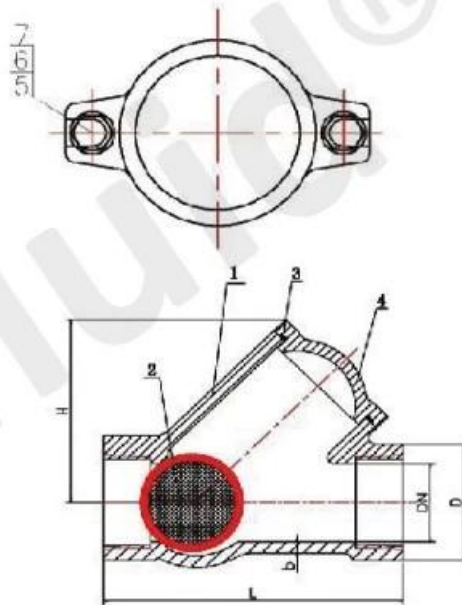

Ball Check Valve, Threaded

ITEM	PART NAME	MATERIAL
1	Body	Ductile iron
2	Ball	NBR
3	O-Ring	NBR
4	Cover	Ductile iron
5	Gasket	SS304

SIZE	DIN 3202 F6	Flange dimension(EN 1092-2) PN10/PN16		
DN	L	D	H	B
DN25	135	50	75	6
DN32	135	50	75	6
DN40	145	60	93	6
DN50	175	72	106	7
DN65	200	90	131	7

Company Advantages

01

21 years of professional experience

03

Independent research and development team
28 top senior professional researchers

05

100% high level ex-factory inspection

07

2 years quality assurance, repair and replacement

4 factories

02

2 professional testing centers

04

High quality imported materials

06

COMPANY INFORMATION





□ □□ □□ : □□ □□ □□, □□ □ □□ □□ □□.

□ □□ CNC □□□ □□, □□ □□ □, □□ □□ □□ □□, □□ □□ □□ □ □□.

□ □□□ □□ □□ □□□ □□ □□ □□ □□ □□□□□.

▣ □□□ □□□ □ □□□ (Houston) □ □□ □□ □□□ □□□□□□.

◆ □□ □□ : GB, □□ □□, □□ □□, TUV CE, ISO 9001, ADWO-2000, TS, PED, WRC WRAS, KTW, API 6D, API609.

VI □□ □□ : □□ □□□ □□, □ □□, □□□ □□, □□ □□, □□□ □□, □□□ □□, □□ / □□ / □□ □□□□□, □□ □□.

Exhibition Photos



Our Certificates



□□□□ □□

Q : □□□□ □□□□ □□ □□ □□□□□?

A : □□□ □□, □□, □□, □□, □□ □□□.

Q : 000000 00 0 0 0000?

A : 000, 00, 00, 00000 00. RKSfluid 000000 00 000 000000. 000 00000, 00 000000.

Q : 000 00 000 00000?

A : RKSfluid 000 000 000 00 0 000 4 00 000 00000.

Q : 00 00 00

A : 0000 000 2 ~ 5 0 (2 ~ 5 0) 0000. 000 000 00 000 00 0 00.

Q : MOQ.

A : 00 000 00 1pc.

Q : 00 000 00000?

A : 00 00 100 % 00 000, 2 0 00. 0000 0000 00000.

000 TUV, API, WRAS, CE, ISO 000 00000.

00, DIN, ASME, BS EN, JIS, API, AWWA.

Q : 0000 000 0000 00 0 0 0000?

A : RKSfluid 000 20 0 000 70 0 000 R & D 00000 00 00, 00 00 0 00 000 00000.