

Ball check valves contain a ball that sits on the seat, which has only one through-hole. The ball has a slightly larger diameter than that of the through-hole (seat). When the pressure behind the seat exceeds that above the ball, liquid is allowed to flow through the valve. But once the pressure above the ball exceeds the pressure below the seat, the ball returns to rest in the seat, forming a seal that prevents backflow. The ball moves up and down inside the valve depending on the flow and seals against the machined seat when no flow or reverse flow occurs and seals against the seat to stop the reverse flow. Ball check valves are typically preferred for use in pumping stations as they are self-cleaning as the ball rotates during the operation and are vertically maintenance-free. RKSfluid offers both flange and thread connections for the Ball Check Valves.

Design	EN 1171
Flange	EN 1092-2
Face to Face	DIN 12266-1
Operation	Self-montion
Medium	Water
Temperature	0-80°C
Seal test	11/18Bar
Body test	15/24Bar
Pressure ratings	PN10/16
Size	DN40-DN500
Material	ductile iron

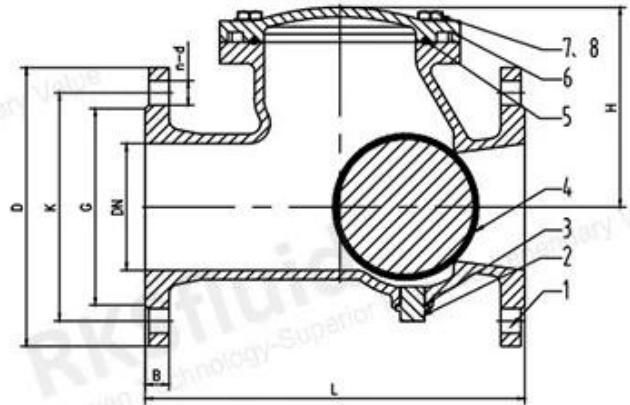

DN40-DN65

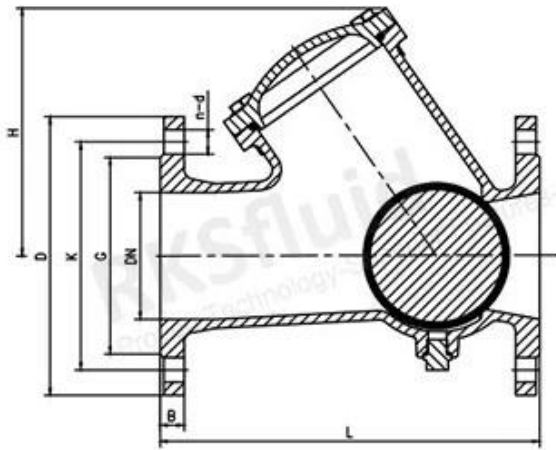
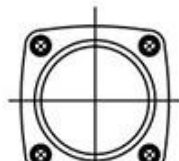

DN80-DN150

DN200-DN500

COMPANY INFORMATION



I Business area: fluid control products, technology and environmental protection products.

II Advanced CNC machining centers, professional process cells, wide-range welding

equipment, automatic assembly lines and coating.

III China's standard reference unit, to participate in the development of relevant valve industry standards.

IV We have set up a research and development center in Houston, Texas, in the United States.

V Product Standard: GB, German Standard, American Standard, TUV CE, ISO 9001, ADWO-2000, TS, PED, WRC WRAS, KTW, API 6D, API609.

VI Main production: butterfly valve, ball valve, gate valve, check valve, globe valves, pipe fittings, manual / pneumatic / electric actuator, valve parts.

COMPANY FACTORY



SHIPPING PACKAGING



COMPANY QUALIFICATION



COMPANY EXHIBITION



Partners



Delivery



Payment



FAQ

Q: If I need quotation, what informations do we need?

A: Valves' materials, Temperature, Pressure, Medium, Appllication System.

Q: Can you provide actuators, what you have?

A: Pneumatic, Electric, Hrdraulic, Solenoid Valves. RKSfluid actuators adopt USA technology. Which you need, just tell us.

Q: What's your productive capacity?

A: RKSfluid has four plants that can provide the products you need.

Q: Production lead time

A: Normal products have stock in 2~5 working days. Customized base on your need.

Q: MOQ

A: 1pc for all products.

Q: How about the quality assurance?

A: 100% quality test before delivery, 2 years warranty. Ensure your system working safety.

We got TUV, API, WRAS, CE, ISO certification.

Standard conform to DIN, ASME, BS EN, JIS, API, AWWA.

Q: How could you provide quality service to our customers?

A: RKSfluid own 27 years experiences and more than 70 R&D engineers provide technical support, model selection and installation guidance for you.